

EXCITING DESIGN FOR THE EXCLUSIVE WAY OF SAILING



388

Hanse 
BREAKING RULES . SETTING TRENDS





EXCITING DESIGN

FOR THE EXCLUSIVE WAY OF SAILING

Segeln. Leben. Genießen. Die neue HANSE 388 macht alles möglich. Das einzigartige Lichtkonzept mit großen Skylights und vielen Rumpffestern garantiert lichtdurchflutetes Wohnen. Das kraftvolle, hohe Rigg und der schnelle Rumpf von judel/vrolijk & co sichern die Freude am Segeln. Das puristische Cockpit und das Deck bieten Platz für Entspannung auf zwei Ebenen. Willkommen an Bord!

Sailing. Living. Enjoying. The new HANSE 388 opens up an exciting world of opportunities. The unique lighting concept centred round large skylights and a host of portholes guarantees living with the utmost of sunlight. The powerful, high rig and the fast hull from judel/vrolijk & co ensure you have sailing pleasure beyond compare. The puristic cockpit and deck offer plenty of space for relaxation on two levels. Welcome aboard!





Auf hoher See zu Hause. Die markanten, schnellen Rumpflinien und der beeindruckende Segelplan stammen aus der Feder von judel/vrolijk & co, den besten und erfahrensten Yacht-Konstrukteuren der Welt. Ebenso ist die Kombination aus perfekt abgestimmtem Lateralplan und vorbalanciertem Ruderblatt ein Garant für Schnelligkeit und Sicherheit.

Feel at home on the high seas. The trademark fast hull line and the impressive sail plan come from the pen of judel/vrolijk & co, the world's best and most experienced yacht construction engineers. The combination of a perfectly harmonised lateral plan and a pre-balanced rudder blade are a further guarantee of high-speed performance and safety while you are sailing.

FAST

CRUISING



Feel the pleasure of

COMFORT & SPEED

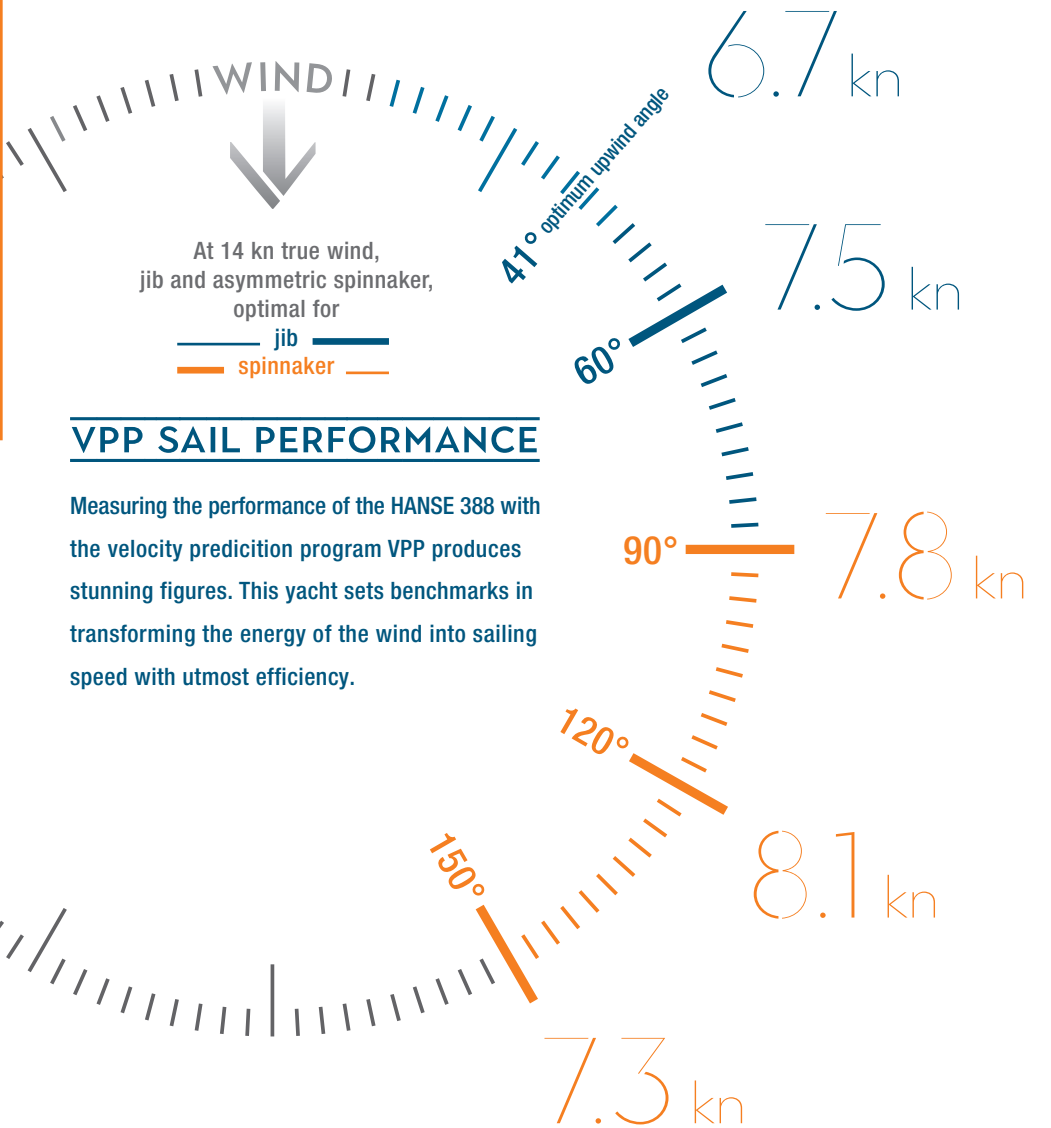

VPP SAIL PERFORMANCE

Measuring the performance of the HANSE 388 with the velocity prediction program VPP produces stunning figures. This yacht sets benchmarks in transforming the energy of the wind into sailing speed with utmost efficiency.

FAST CRUISING

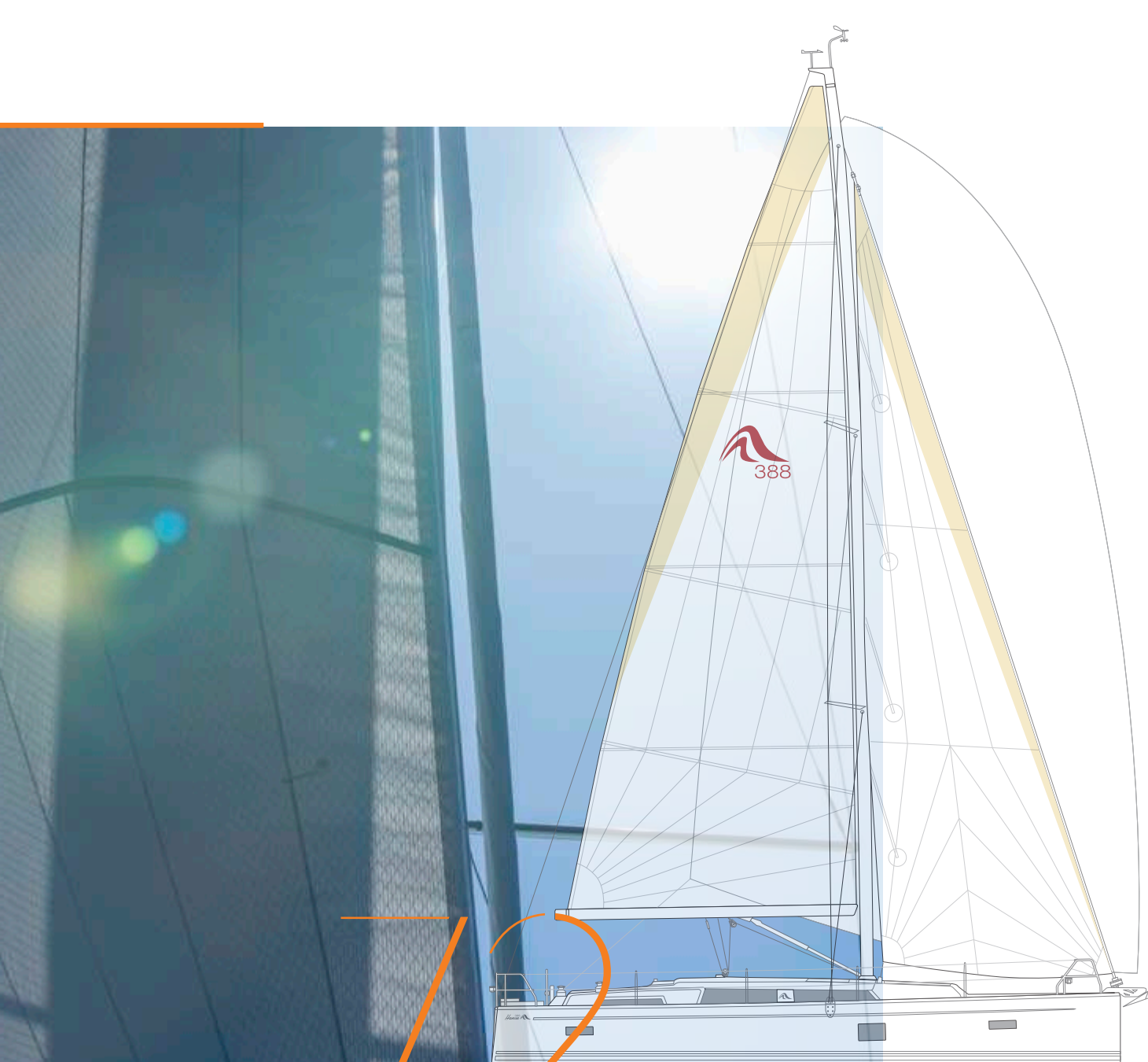

RIG & SAIL OPTIMISATION

Ein hohes Rigg ist das Markenzeichen von HANSE. Die Yachtdesigner von judel/vrolijk & co passen den Segelplan mit hochentwickelten Berechnungsmodellen perfekt an jede HANSE an. Das garantiert beste Segeleigenschaften bei allen Bedingungen und macht eine HANSE zu der schnellsten Yacht in ihrer Klasse.

A high rig is the trademark of every HANSE. The yacht designers from judel/vrolijk & co perfectly form the sail plan for each HANSE with the use of highly sophisticated calculation models. This guarantees that you have the best sailing characteristics under all conditions, and it ensures your HANSE is the fastest yacht in its class.

+ 94 m²
GENNAKER

m² TOTAL SAIL AREA

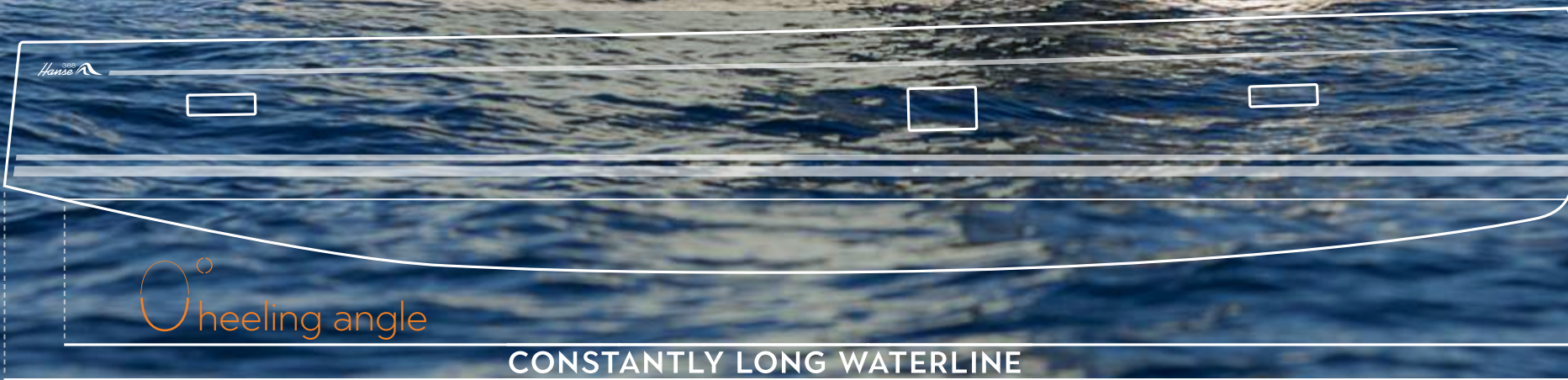

15° heeling angle

CONSTANTLY LONG WATERLINE

Voraussetzungen für eine herausragende Performance sind das steile Heck und der gerade Steven. Dieses intelligente Design ermöglicht eine optimal lange Wasserlinie bei jedem Krängungswinkel – und damit eine überlegene Geschwindigkeit auf allen Kursen.

Outstanding performance comes from having a steep stern and a straight stem. This intelligent design provides an optimal, long waterline at any heeling angle – and superior speed for you on all courses.

FAST CRUISING



LOA
11.4 m

BEAM
3.9 m

DRAFT
2.1 m

DISPLACEMENT
8.3 t

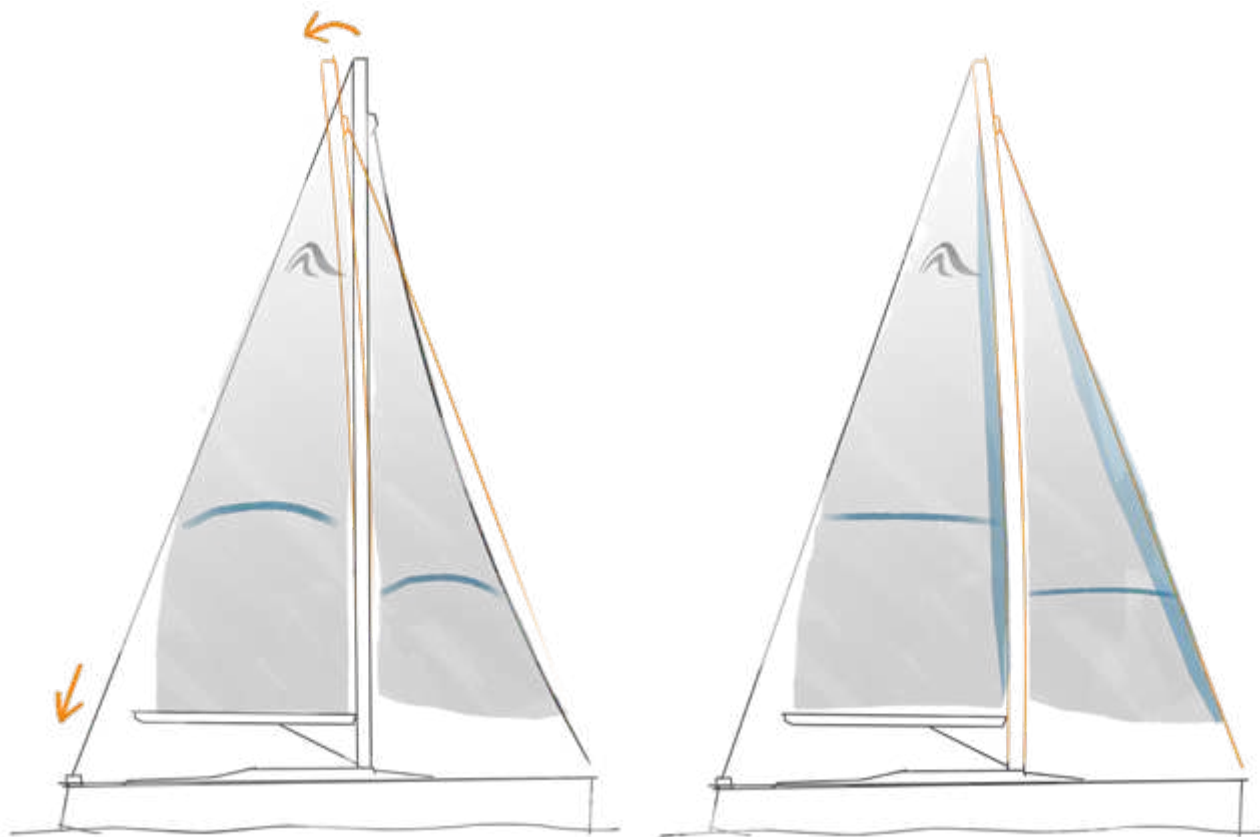

HANSE SMART TRIM SYSTEM

Wir trimmen die Segel wie die Profis und setzen auf ein Achterstag, das sich stufenlos verstellen lässt. Damit können Mastbiegung und Profiltiefe der Segel jederzeit dem Wind angepasst werden.

We have trimmed the sails so you can sail like a pro and included a backstay, which can be adjusted seamlessly. This enables the mast and the profile of the sail to perfectly adapt to the wind at all times.

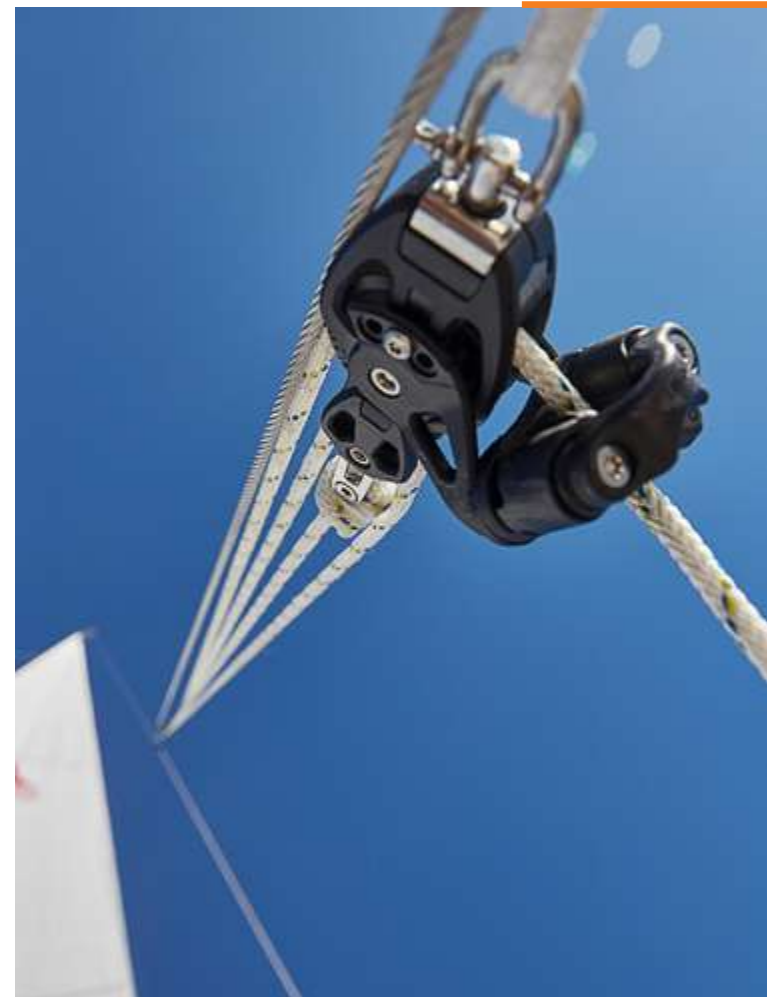

FAST CRUISING



Das HANSE Easy-Sailing-Concept ist legendär. Wir haben die integrierte Selbstwendefock konzipiert und alle Leinen zum Steuerstand geführt. So können Sie diese Yacht auch ganz allein Segeln. Das Reffen, Wenden und Segelsetzen erledigen Sie vom Steuerstand aus, ganz ohne Anstrengungen. Das Deck ist kompromisslos frei von Leinen und Beschlügen, damit Sie unterwegs und im Hafen viel Platz zum Entspannen haben. So geht Segeln heute!

The HANSE Easy Sailing Concept is legendary. We invented the integrated self-tacking jib and brought all the lines to the helm. This means you can sail your yacht on your own. Reefing, tacking and setting sail can all be performed from the helm without any effort. The deck is free of lines and fittings, giving you uncompromising comfort and space while you are at sea or relaxing in the harbour.

EASY SAILING



Hanse

HANSE ONE-ROPE REEF SYSTEM

Sie bestimmen die Größe der Segelfläche – und das ganz bequem vom Cockpit aus. Das HANSE Einleinen-Reffsystem ermöglicht einfaches und schnelles Handling.

You decide the size of the sail area – easily from the comfort of the cockpit. The HANSE One-Rope Reef System ensures that handling is quick and effortless for you.

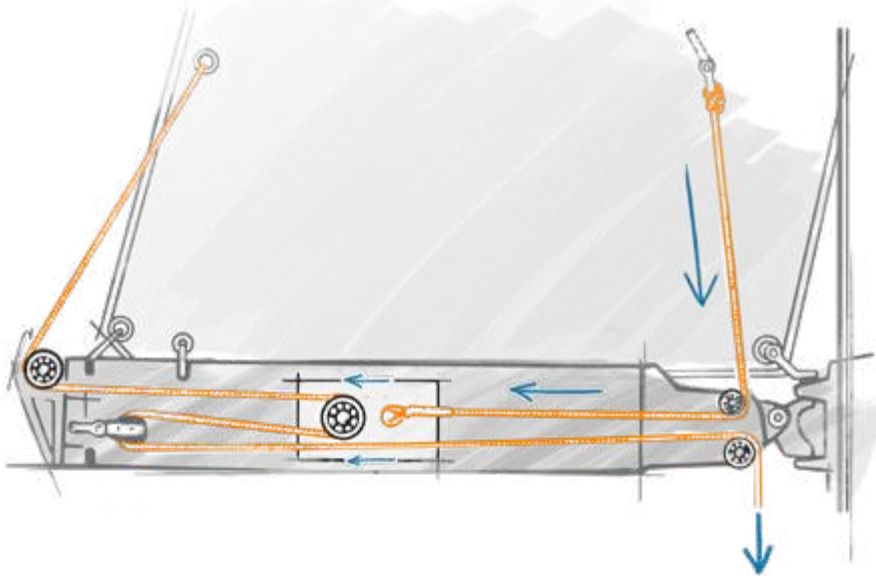

PURE DECK & COCKPIT

Clean und cool. Alle Flächen sind puristisch klar und aufgeräumt gestaltet. Die Fallen und Schoten haben wir elegant unter Deck verschwinden lassen.

Clean and cool. All spaces feature a minimalist design, with a pure and clear structure. We have even hidden the halyards and sheets elegantly below the deck.

HANSE SELF-TACKING JIB

Die Selbstwendefock ermöglicht einfache und schnelle Manöver. In der Wende oder Halse gleitet das Vorsegel über die integrierte Decksschiene von selbst auf die richtige Seite.

The self-tacking jib lets you manoeuvre the yacht easily and quickly. In the tack or the jib, the headsail smoothly glides over the integrated deck rails automatically to the correct side.

EASY SAILING

HANSE RUDDER BALANCE

Beim Design der Ruderanlagen setzt HANSE kompromisslos auf Sicherheit – bei gleichzeitiger Agilität. Deshalb haben wir ein vorbalanciertes Ruder entwickelt, dessen wirksame Oberfläche überdurchschnittlich groß ist. Damit lässt sich die Yacht in jeder Situation spielend leicht steuern.

When it comes to the design of the rudder system, HANSE gives you high agility without compromising safety. For this, we have developed a pre-balanced rudder whose efficient surface is larger than average. It makes steering the yacht in any situation child's play.

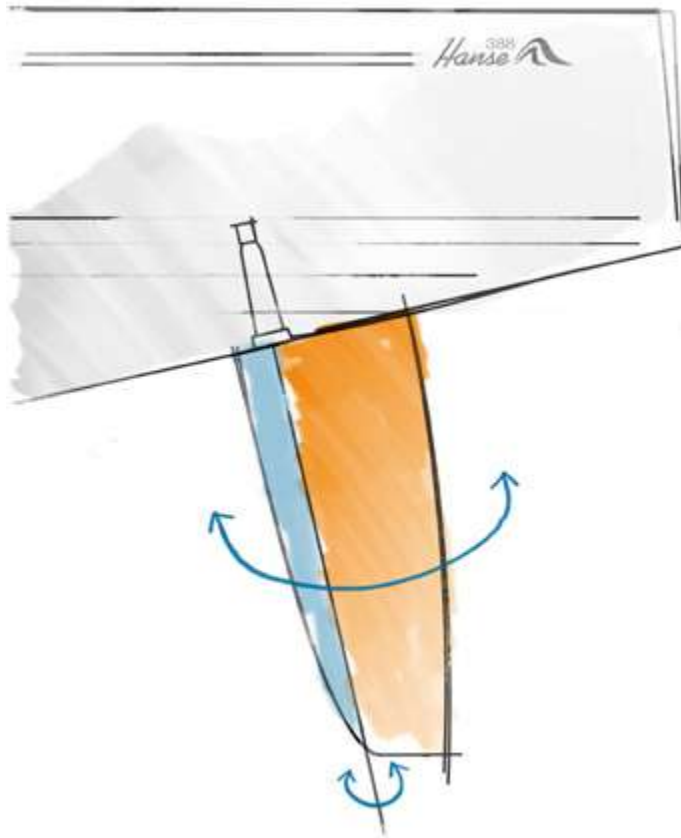

HANSE CROSSOVER SAIL

Das HANSE Crossover-Segel ist die eindrucksvolle Inszenierung eines ultramodernen Reackkurs-Segels, das mit feinsten Komponenten und technischem Know-how ausgestattet ist. Einzigartig ist die einfache Handhabung als Rollsegel sowie das enorme Einsatzspektrum von 65 bis 140 Grad zum Wind.

The HANSE Crossover Sail is the impressive result of an ultra-modern sail perfect for when you are on a reach course. Equipped with the finest components and rich in technical finesse, this cutting-edge sail is unique in both its ease-of-use as a Genoa sail and its enormous spectrum of usage – from 65 to 140-degrees to the wind.



180 CONTROL

HANSE HELSMAN CONTROL

Segeln per Knopfdruck? Bei HANSE keine Vision, sondern Wirklichkeit! Steuern Sie die gesamte Technik bequem vom Cockpit aus. Alle Schoten und Fallen führen zum Steuerstand, somit haben Sie die absolute Kontrolle in allen Segelmanövern.

Sailing at the touch of a button? With HANSE, your dream is now reality! Control the entire system from the cockpit. All the halyards and sheets also lead to the helmsman. This gives you absolute control in all sailing manoeuvres.

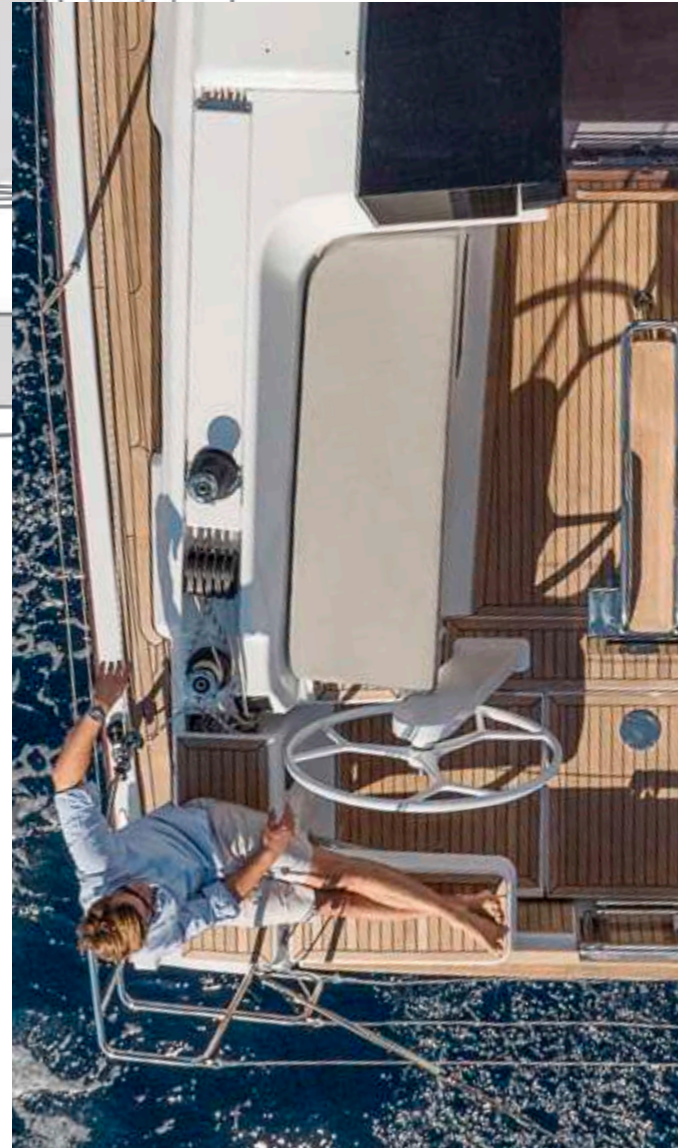

EASY SAILING



In allem einen Schritt voraus. Technische Innovationen und Detailqualität sind ebenso ein Teil von HANSE, wie emotionale Formensprache und Wohlfühlatmosphäre. Dabei setzt jedes Detail ein klares Design-Statement. Das perfekte Zusammenspiel fortschrittlicher Technologie und ihrer Umsetzung im Design ist unser Anspruch an die perfekte Yacht.

With HANSE, you have a progressive yacht that makes a statement. Technical innovations and quality in every detail are just as much part of the HANSE 388 as are an emotional design and comfortable atmosphere of well-being. Each detail is a subtle expression of superior design. The well-orchestrated ensemble of advanced technology and its integration is the highest art of yacht design at HANSE – and what drives us to create the perfect yacht.



DESIGN

INNOVATIVE





HIGH EXTERIOR&INTERIOR LIGHTS

1 Ergonomische Steuermannssitze mit Klappfunktion **2** Doppelsteueranlage **3** Clever im Seitendeck eingelassener Leinenstauraum **4** Cockpittisch mit herunterklappbaren Tischblättern sowie Handläufen und Fusstützen aus Chromstahl **5** Elegante Glas Skylights mit zu öffnenden Bullaugen **6** HANSE Selbstwendefock **7** Zwei Luken plus ein Oberlicht für das hellste Vorschiff dieser Klasse **8** Achterkabinen mit viel Licht und großen Kleiderschränken **9** Helles, geräumiges Bad mit HANSE Design-Waschbecken **10** Kolorierte Oberschränke in Pearl Grey oder Dove Grey **11** Absenkbarer Kartentisch für große Chaiselongue an Backbord **12** Erweiterbare Familien-Salonlounge **13** Salontisch mit ausziehbarem Barfach **14** Mehr Tageslicht durch große Rumpffenster **15** 32 Zoll Flachbildfernseher **16** Großzügige Eignerkabine mit Stehhöhe und viel Licht

1 Ergonomic helmsman seats with folding function **2** Twin wheels **3** Rope storage cleverly integrated into the side deck **4** Cockpit table with fold-down tabletops as well as handrails and footrests made of chrome steel **5** Elegant glass skylights featuring opening portholes **6** HANSE self-tacking jib **7** Two hatches plus skylight for the most sunlight in a forecastle of this class **8** Aft cabin with lots of light and large wardrobes **9** Bright, spacious bathroom featuring HANSE designer sink **10** Upper cupboards in the colours Grey or Dove Grey **11** Lowerable chart table to create a large chaise longue portside **12** Extendable family saloon lounge **13** Saloon table with pull-out bar compartment **14** More daylight thanks to large hull windows **15** 32-inch flat-screen TV **16** Spacious master cabin with headroom and lots of light



Höchster Segelgenuss, durch Helligkeit, Funktionalität und stimmige Proportionen.

1 Große und elegante Glasfenster umgeben den Bereich des Niedergangs.

2 & 3 Die Vielzahl an zu öffnenden Skylights und die großen Rumpffenster erzeugen einen hohen Lichteinfall und eine erfrischende Atmosphäre.

4 Das klare und leinenfreie Decks- und Cockpitlayout ist für perfekte Sommertage auf See und im Hafen konzipiert.

Highest sailing pleasure thanks to daylight, functionality and harmonious proportions.

1 Large and elegant glass windows enwrap the companionway area. **2 & 3** The high number of opening skylights and the large hull windows let in lots of light to create a refreshing atmosphere.

4 The clear and rope-free deck and cockpit layout are perfect for summer days at sea and in the harbour.



LIGHT & SPACE

Enjoy your freedom



INNOVATIVE DESIGN



Das HANSE Cockpit-Konzept perfekt umgesetzt: **1** Ergonomischer Steuerstand mit eleganten, sportlichen Steuerrädern im Y-Spoke Design. **2** Exklusiv von HANSE entwickelt: Große Badepattform mit Teakholz und integrierter Badeleiter. **3** Clever in das Seitendeck integriert: Der Leinenstauraum am Steuerstand. **4** Freier Zugang zur Badeplattform durch hochwertige Steuermannssitze mit Klappfunktion.

The HANSE cockpit concept in perfection: **1** Ergonomic control station with elegant, sporty steering featuring a Y-spoke design. **2** Exclusively developed by HANSE: the large bathing platform with teak and integrated bathing ladder. **3** Cleverly hidden in the side deck: the rope storage at the control station. **4** Free access to the bathing platform thanks to high-quality helmsman seats with fold-down function.

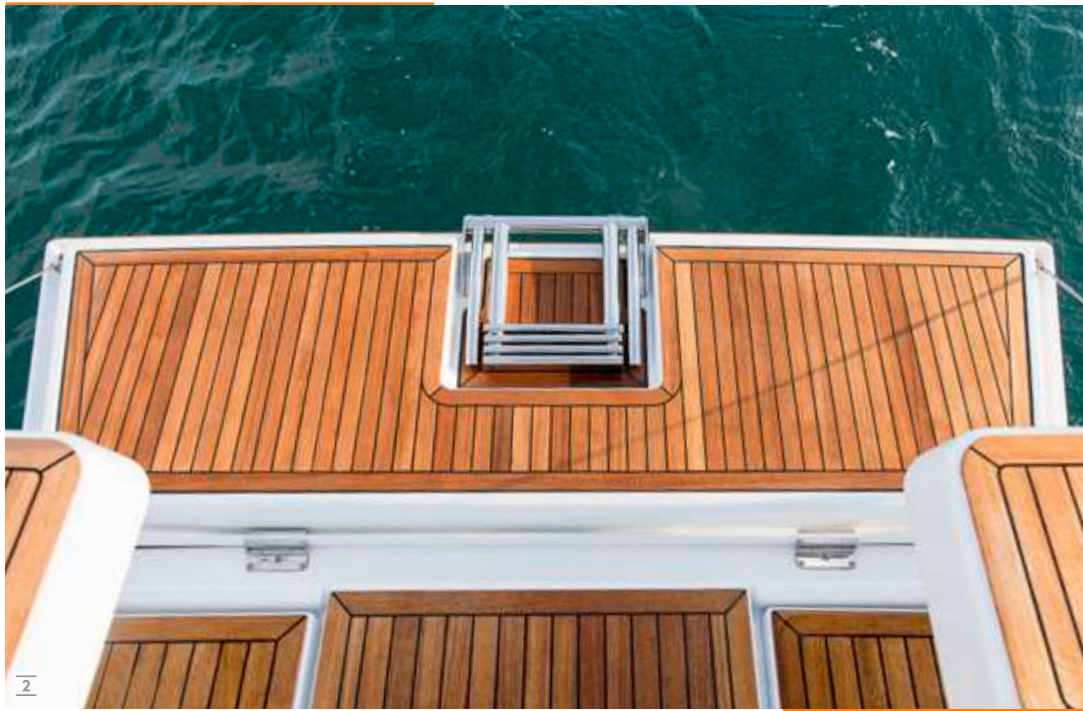

INNOVATIVE DESIGN





INNOVATIVE INTERIOR DESIGN

Faszinierend schön: Die Kombination aus indirekten Lichtakzenten und Sonnenlicht. Das optische Zusammenspiel einer Vielzahl feinsten Stoffe und edler Möbeloberflächen. Die intelligente Raumnutzung, verbunden mit verschiedenen Layoutvarianten. Die HANSE 388 definiert, wie Segeln auf 38 Fuß heute aussieht.

Fascinatingly beautiful: the combination of indirect lighting accents and sunlight. The optical interplay of the many fine materials and elegant furniture finishings. The intelligent use of space coupled with the various layout versions. The HANSE 388 defines modern sailing along 38 feet.



CABINS & DETAILS

1 Die HANSE 388 besticht durch ihr schickes Ambiente, großzügige, helle Kabinen, hochwertige Ausstattungsdetails und eine wunderbare Aussicht ins Blaue. 2 Im Detail maßgeschneidert: Edel bezogene Stoffpaneele. 3 Die ausziehbare Relaxing- oder Familienlounge.

1 The HANSE 388 is characterised by its chic ambience, spacious and light cabins, high-quality furnishings and details, and wonderful view out into the blue. 2 Tailored en detail: elegantly upholstered panels. 3 The fold-out lounge for relaxing or fun family moments.

State of the art living

MODERN AMBIENCE



Wohlfühlambiente wird auf der HANSE 388 besonders durch indirekte LED Lichter und ausgewählte Materialien erzeugt. **1** Elegante Kombination aus gewebten Florence Anthrazit Polsterstoffen und hellem French Oak Interieur. **2** Edle Tropfen sicher gelagert: Das integrierte Barfach im Salontisch als Designstatement.

The ambience of well-being on the HANSE 388 is especially thanks to the indirect LED lights and select materials. **1** Elegant combination of woven Florence upholstery fabrics in Anthracite and light French Oak interior. **2** Fine wines safely stored in the bar compartment integrated into the saloon table as a design statement.



1 Viel natürliches Licht und das helle Design sorgen für ein angenehmes Ambiente in der Eignerkabine im Vorschiff. 2 Große Kleiderschränke mit viel Stauraum an Backbord und Steuerbord.

1 Lots of natural light and the light-coloured design provide a comfortable ambience in the master cabin at the bow. 2 Large wardrobes with plenty of storage portside and starboard.





1 & 2 Großzügige Gästekabinen mit maximaler Stehhöhe, ausreichendem Stauraum, großem Doppelbett und viel natürlichem Licht durch Glas Skylights. **3** Das großzügig gestaltete Bad empfängt Sie mit einem indirekt beleuchteten Spiegel, das extra entwickelte HANSE Design-Waschbecken mit Unterschrank bietet genug Stauraum für alle Utensilien.

1 & 2 Spacious guest cabins with maximum headroom, plenty of storage, large double bed and lots of natural light thanks to glass skylights. **3** The generously designed bathroom awaits you with a mirror featuring indirect lighting. The HANSE design sink, specially created for HANSE yachts, features a cupboard with plenty of space for all your personal care needs.

CABINS & DETAILS



Furniture

CANADIAN CHESTNUT SATIN VARNISH

Cupboard Fronts

DOVE GREY





SPACE FOR INSPIRATION

Lassen Sie sich inspirieren und sehen Sie hier Beispiele für verschiedenste Ausbauvarianten und Oberflächen Ihrer HANSE 388. Auf den folgenden Seiten zeigen wir, wie Sie Ihre HANSE genau nach Ihren Vorstellungen einrichten können. Angefangen beim individuellen Kabinen-Konzept bis hin zu den vielen Möglichkeiten an Hölzern, Stoffen und Farben.

Be inspired for your own yacht with our examples of various layouts and surfaces for your HANSE 388. On the following pages, you will discover how you can make your HANSE truly your own – from individual cabin concepts to many options for wood, fabrics and colours.

Gestalten Sie selbst: **1** Puristisch modernes Interieur in French Oak mit Noce Nero Boden. **2** Nautisch elegant in Mahagoni mit Delight Oak Boden. **3** Der absenkbare Kartentisch an Backbord verwandelt das Sofa in eine große Chaiselongue.

Create your own design: **1** Minimalist and modern interior in French Oak with Noce Nero floorboards. **2** Nautical and elegant in Mahogany with Delight Oak floorboards. **3** The lowerable chart table portside turns the sofa into a large chaise longue.







Wohin Sie auch segeln – Ihre HANSE ist ein Unikat. Wählen Sie die Farbe des Rumpfes und auf welchen Polstern Sie Ihren Sundowner genießen. An Deck bestimmen Sie über die technische Ausstattung Ihrer HANSE Yacht. Auch das Interieur trägt Ihre Handschrift. Genießen Sie die Freiheit auf See in einem coolen Loft oder umgeben von maritimer Eleganz. Wählen Sie einfach die für Sie perfekten Materialien und exklusiven Ausstattungen aus!

Wherever you sail – your HANSE is one of a kind. You choose the colour of the hull and which upholstery you would like to catch your eye. On deck, the decision of which technical equipment to include on your HANSE yacht is all yours. The interior also carries your signature. Enjoy the freedom at sea in a modern loft atmosphere or surrounded by maritime elegance. High-quality materials and exclusive fittings await you.



INDIVIDUAL

CUSTOMISATION

 388



Segeln Sie am liebsten zu zweit, mit der Familie oder im großen Freundeskreis? Die Raumaufteilung Ihrer HANSE 388 lässt sich individuell Ihren Wünschen anpassen. Sie haben die Wahl zwischen dem klassischen Standardlayout oder einem maßgeschneiderten Kabinen-Konzept für mehr oder weniger Gäste an Bord.

Do you prefer to sail with loved ones, your family or with a group of friends? The below-deck layout of your HANSE 388 can be adapted to your individual needs and desires. You can choose between the classic layout and a tailor-made cabin concept for many or just a few guests on board.



CABIN

INDIVIDUAL CONCEPT

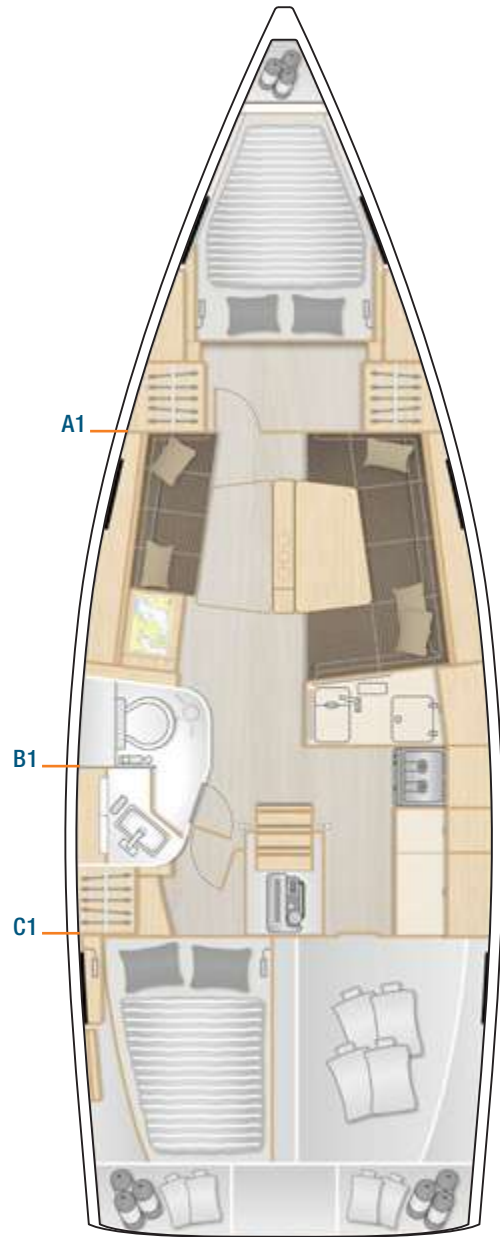

Standard

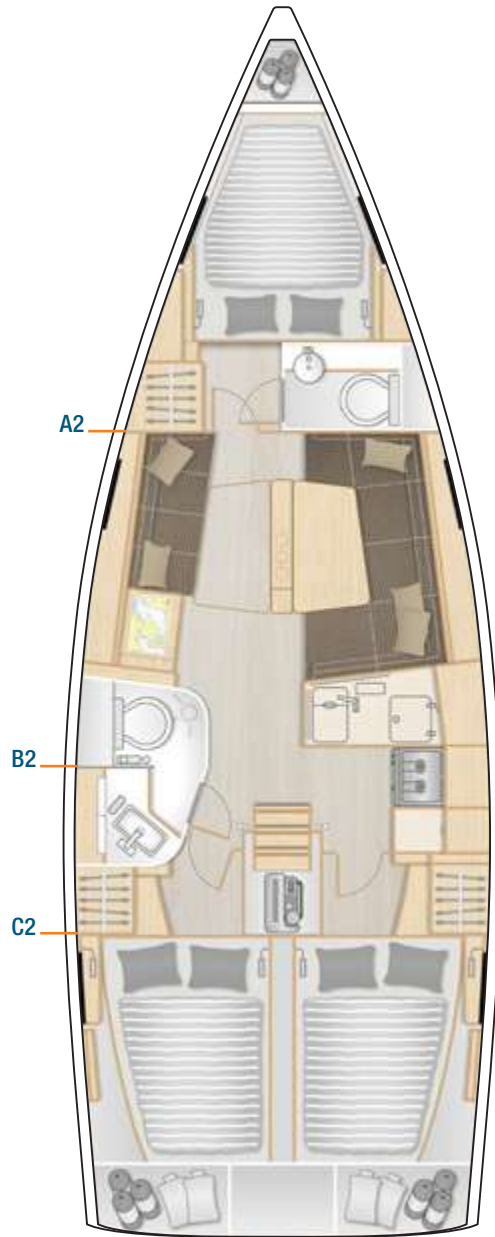

Option

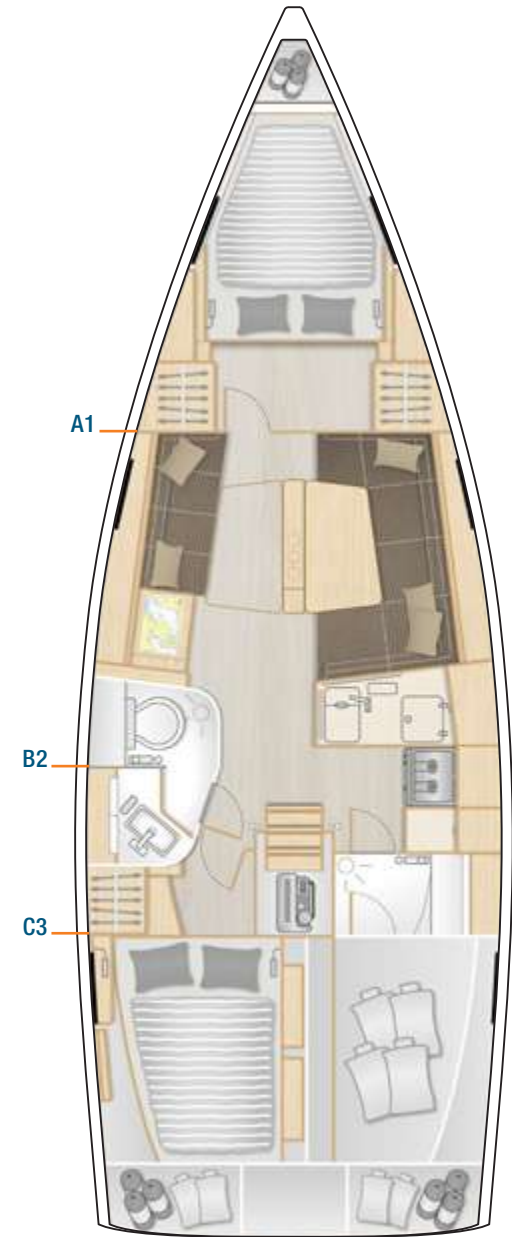

Option



TEAK DECK

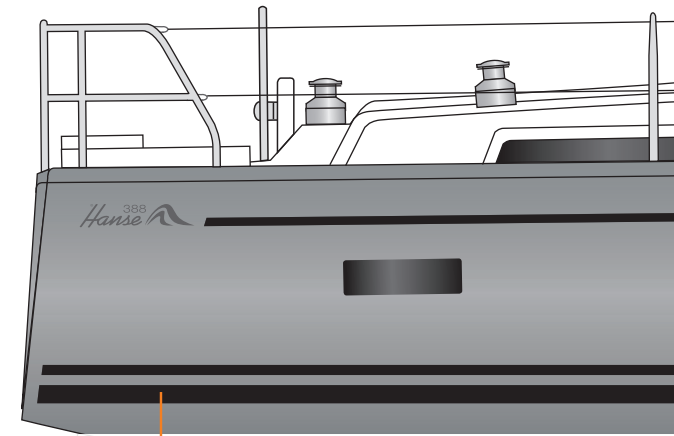

Black
RAL 9011
Option



TEAK & SYNTHETIC TEAK

Options: **1** Teak · Synthetic Teak: **2** Teak Black
3 Teak Grey **4** Teak White **5** Scrubbed Black
6 Scrubbed Grey **7** Scrubbed White **8** Weathered Black **9** Weathered White

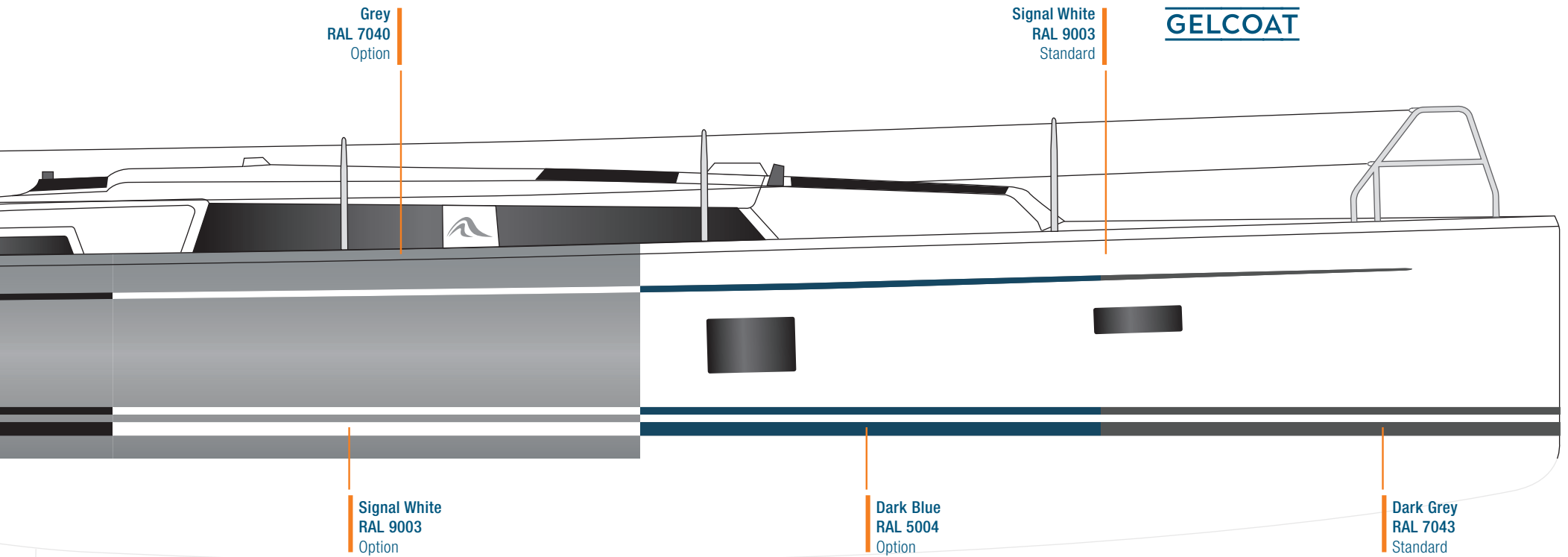

Gelcoat Rumpf- oder Wasserpassfarben. Bei HANSE können Sie Farbe bekennen, aus einer Vielfalt an Möglichkeiten.

Gelcoat hull and waterline colours. At HANSE, you can select your favourite colour for your new yacht.

COLOURS

HULL & WATERLINE

STYLE

CREATE
YOUR OWN
LIFE

Eine individuelle Yacht für eine einzigartige Persönlichkeit. Wer eine HANSE segelt, will das Besondere. HANSE bietet Ihnen die Möglichkeit, dieses Besondere ganz persönlich zu gestalten. Ihrer Fantasie sind kaum Grenzen gesetzt. Unsere Experten helfen Ihnen gerne bei der Auswahl.

Your own individual yacht for your unique personality. Discerning connoisseurs sail HANSE, as we offer you the chance to express your style personally. There are no limits to how creative you can be. Our experts are happy to support you in choosing the perfect accents.



LAZY BAG . BIMINI . SPRAYHOOD . COVER

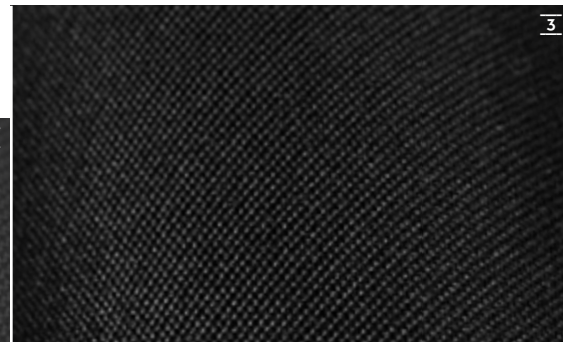
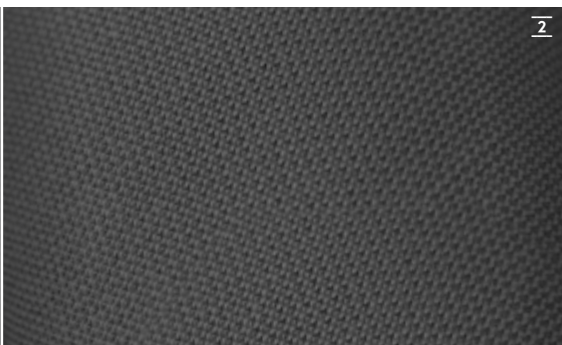

Options: [1](#) Light Grey [2](#) Dark Grey [3](#) Black [4](#) Cream

CUSHIONS FOR COCKPIT . SUNBED . HELMSMAN SEATS

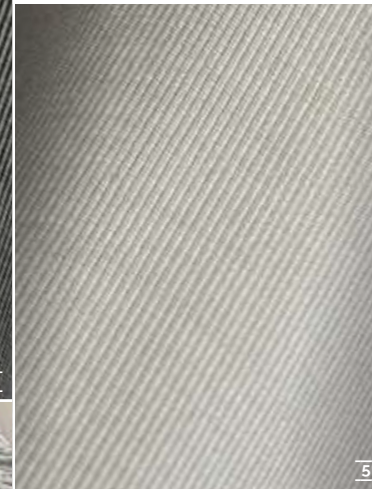
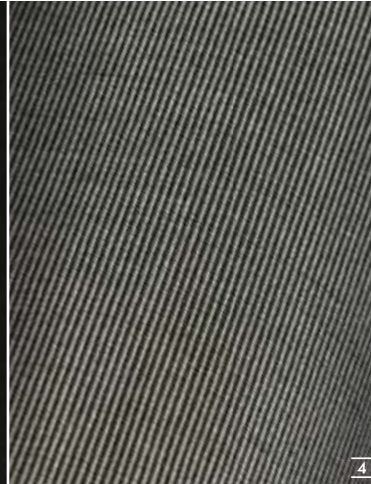

Options:

1 Dark Blue **2** Red **3** Black **4** Dark Grey **5** Light Grey **6** Cream

FABRICS EXTERIOR

FURNITURE

Marine optimized real wood veneer from ALPI.

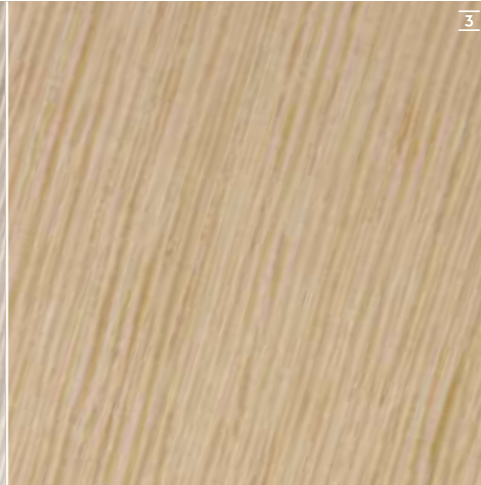

Standard: [1](#) Mahogany Style Satin Varnish · Options: [2](#) Canadian Chestnut Satin Varnish [3](#) French Oak

FLOORBOARDS

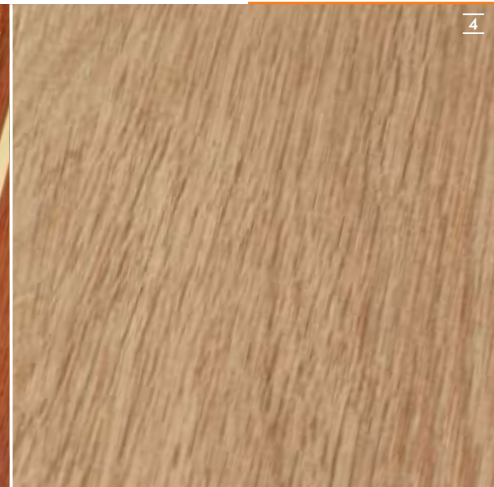
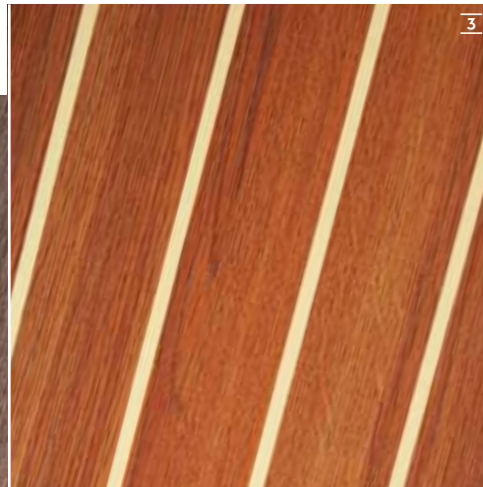
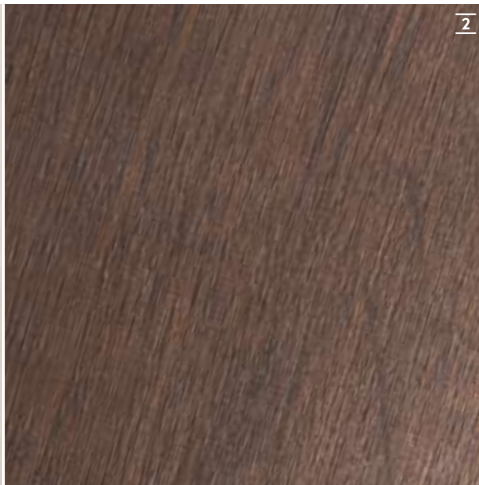
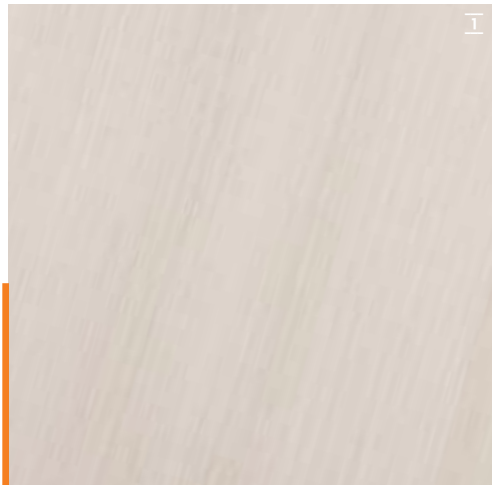

Standard: [1](#) Acacia · Options: [2](#) Noce Nero [3](#) Classic Stripes [4](#) Delight Oak



CUPBOARD FRONTS



Options: [1](#) Pearl Grey [2](#) Dove Grey

WORKTOP GALLEY

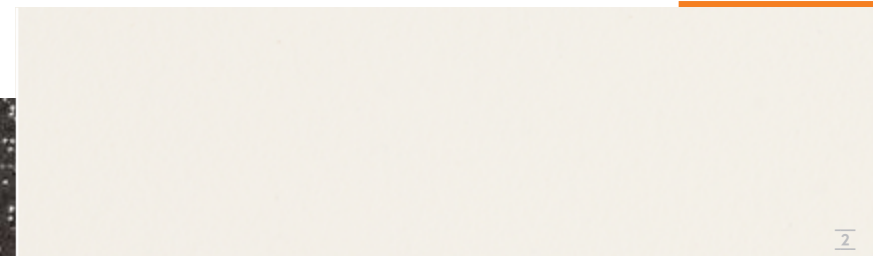

Standard: [1](#) Black Quartz - Option: [2](#) Seashell White

FABRICS INTERIOR



PORTOFINO LEATHER

Options: 1 Ivory 2 Basalt 3 Mud 4 Clay 5 Chocolate



SORRENTO

Options: 1 Taupe 2 Silver 3 Stone 4 Charcoral 5 Denim





MONTE CARLO

Standard: Cream



MONACO

Options: 1 Almond 2 Bronze 3 Rock Island
4 Black Truffle 5 Husky

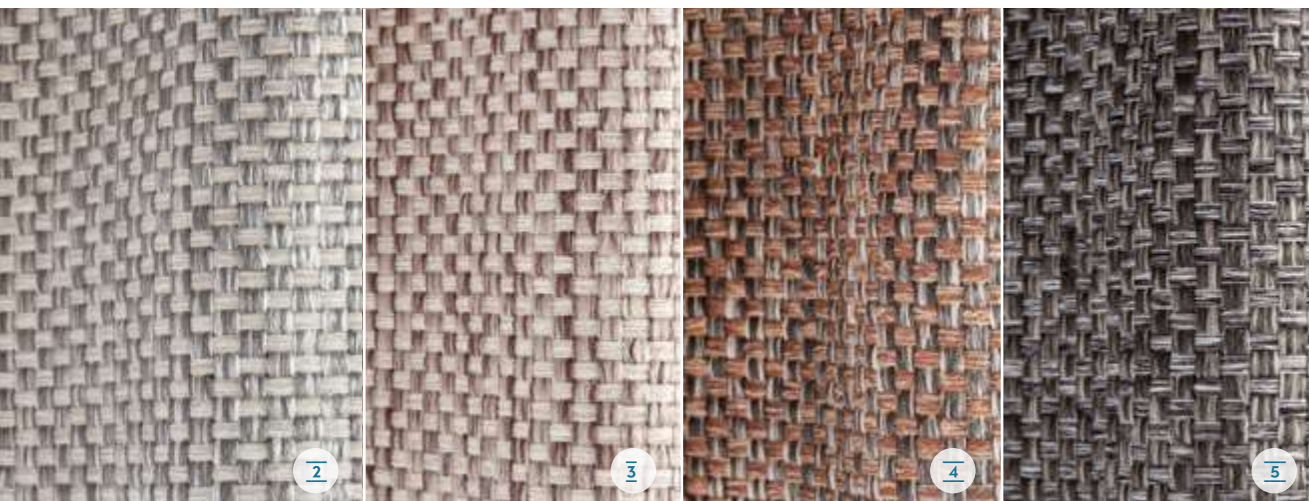

FLORENCE

Options: 1 Cliffside 2 Glacier
3 Oyster 4 Muscat 5 Graphite



1 Coast Gold 2 Red 3 Dark Blue 4 Ocean Blue 5 Black 6 Grey 7 Natural

And many more colours - it's your choice.

GENNAKER

HANSE CROSSOVER SAIL

- Segel Performance ab 5 Knoten Wind
- Segelfläche 61,10 m² (ca. 658 sq ft)
- Größtes Windrichtungsspektrum seiner Klasse
- Grüne Alternative zum Motor
- Idealer Zusatz zur Selbstwendefock
- Zweites Vorstag

- Sailing performance from 5 kn wind speed
- Sail area 61,10 m² (approx. 658 sq ft)
- Largest wind angle range in its class
- Green alternative to the engine
- Ideal complement to the self-tacking jib
- Additional forestay

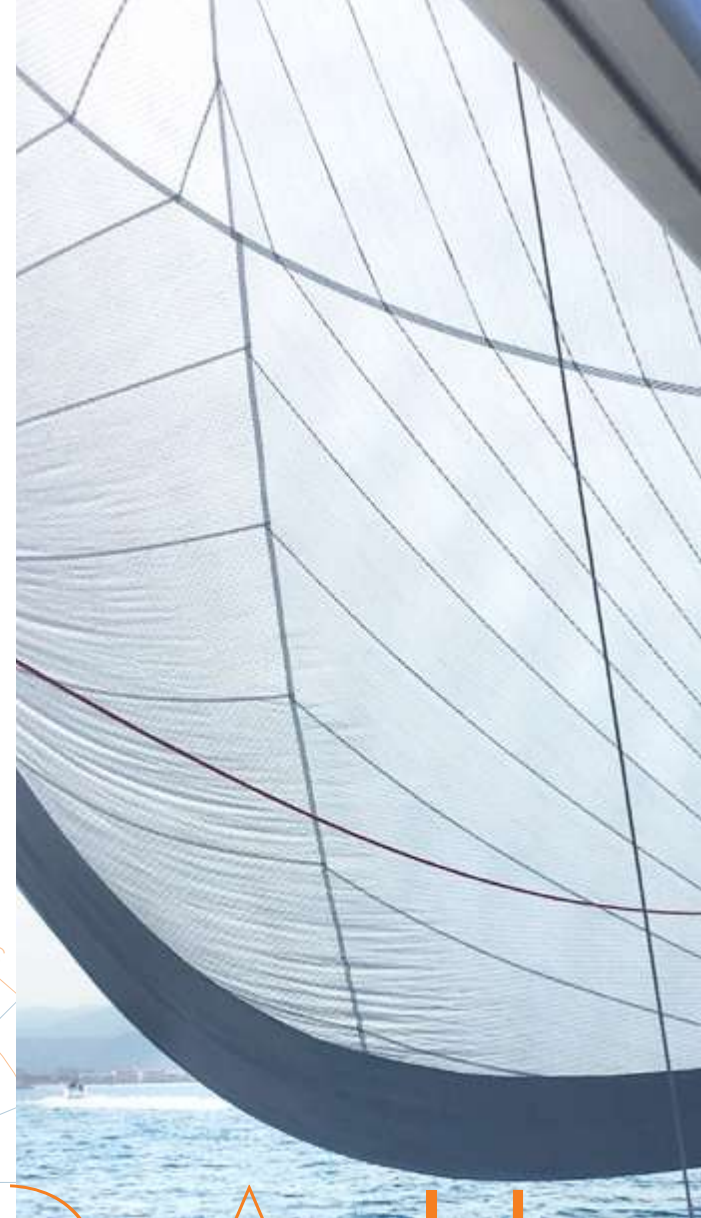
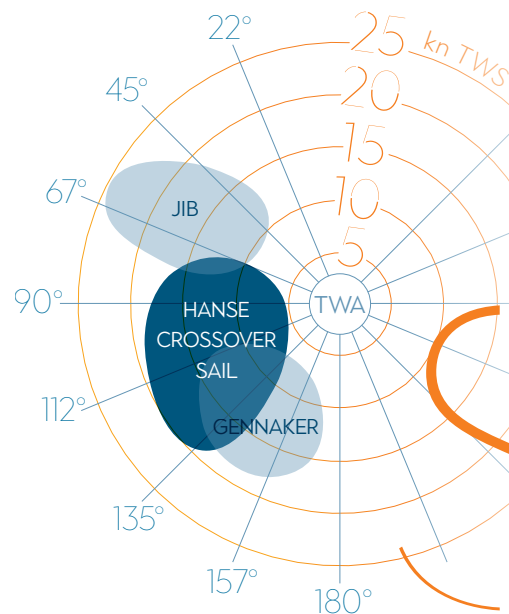

CROSSOVER

TECHNOLOGY

Die Quantum iQ Technology® in Kombination mit präziser Handwerkskunst nach dem neuesten Stand der Technik machten die Entwicklung des Quantum Segels AC5 Active Cruising erst möglich. Die AC5 Segel wurden so designed, dass keiner Ihrer Wünsche an ein Segel offen bleibt: extrem vielseitig, langlebig und einfach zu bedienen. So meistern Sie alle Herausforderungen, die ein aktiver Segel-Lifestyle mit sich bringt.

The Quantum Sails AC5 Active Cruising sails were engineered using Quantum's iQ Technology® design process paired with precision craftsmanship using state-of-the-art materials and tools. The AC5 sails are designed to give you the experience you want, while also being extremely versatile, durable, and easy to use so that you can confidently face whatever challenges your active cruising lifestyles brings.

MAIN SAIL DETAILS

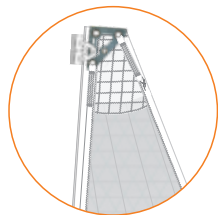

Head Corner Patch

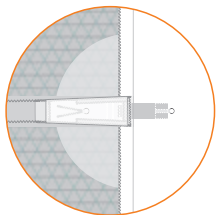

Batten Tensioning System

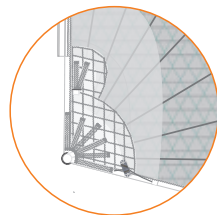

Tack Corner Patch

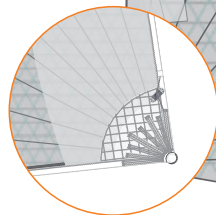

Clew Corner Patch

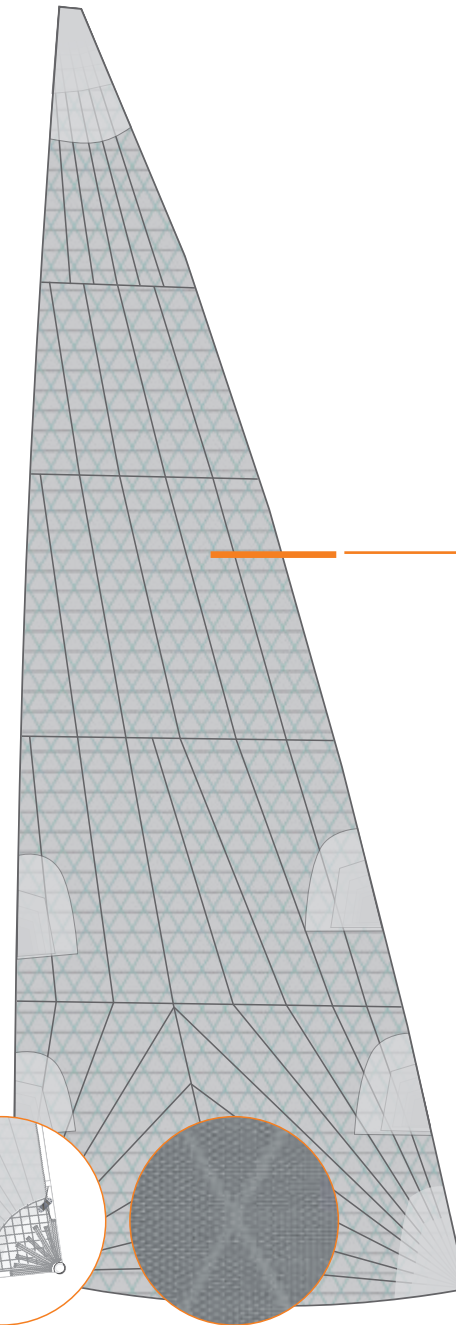

ACTIVE CRUISING SAILS

- QUANTUM SAILS iQ TECHNOLOGY®
- Höhere Formstabilität für bessere Segeleigenschaften
- Längere Lebensdauer für den ambitionierten Fahrtensegler
- Für HANSE Yachten exklusiv designed von Quantum
- Custom panel design

- QUANTUM SAILS iQ TECHNOLOGY®
- Increased stability for high performance
- High durability for ambitious cruising
- Exclusive design by Quantum for HANSE yachts
- Custom panel design

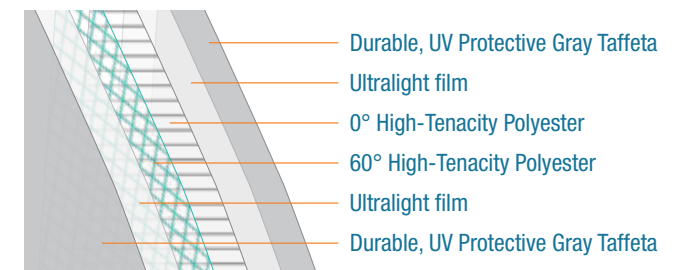

PERFORMANCE SAILS

NAVIGATION PACKAGE B&G



B&G Zeus³S 9" chart plotter
at cockpit table



2 B&G Triton² multifunction displays
in cockpit
incl. transducer (wind/speed/depth/temperature)



TV PACKAGE SALOON

- TV preparation in saloon
- Flat-screen LED TV in saloon
- DVB-T2 antenna for TV

ENTERTAINMENT PACKAGE SALOON & COCKPIT



UPGRADE 12" CHART PLOTTER



B&G Zeus³S 12" chart plotter
at cockpit table

UPGRADE NAVIGATION PACKAGE



B&G VHF V60
at chart table,
incl. wireless remote handset H60

VHF preparation
with antenna and
splitter for FM and AIS

B&G Autopilot
with Triton² control unit
and Precision 9 compass

UPGRADE PREMIUM RADIO



FUSION MS-RA70N Multimedia radio
with Bluetooth® for saloon und cockpit
Wireless charging



FUSION MS-NRX Remote Control
– Watertight control of all functions
in cockpit
– Control of iPod/iPhone music library
– Display of speed, depth, wind and
GPS via NMEA 2000 interface



2 high-end 2-way speakers
in saloon
2 high-end 2-way speakers
in cockpit
- Shock resistant, watertight



FUSION MS-AV755 Multimedia radio
with Bluetooth® and CD/DVD player,
for saloon und cockpit
FUSION wireless link
remote control via mobile devices

NAVIGATION & ENTERTAINMENT

X^{MORE}TRAS

388

Die Optionsvielfalt von HANSE gibt Ihnen mehr Freiheit – räumlich und gestalterisch. Hier finden Sie ausgesuchte Extras für Ihre HANSE 388.

The variety of individual options at HANSE gives you more freedom – spatially and artistically.

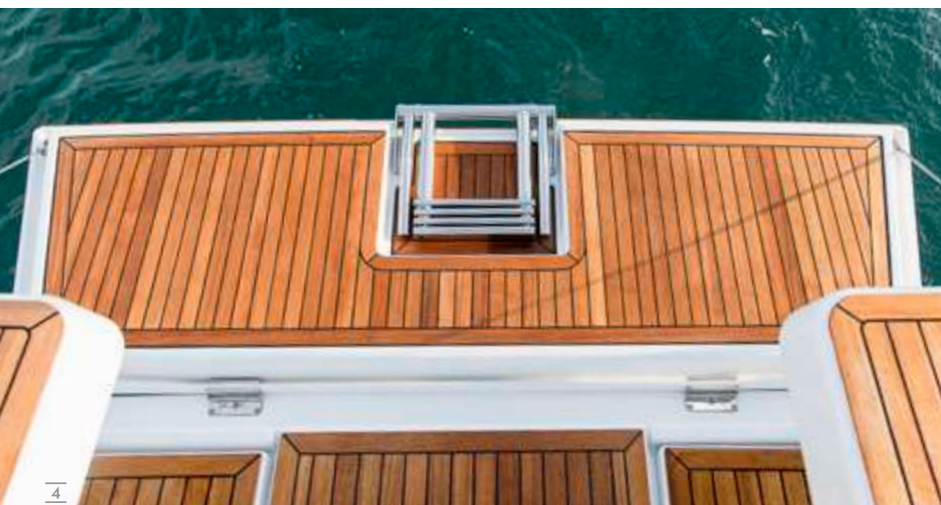

- 1 Ergonomische Steuermannssitze mit Klappfunktion 2 Edles Teakholz oder strukturechtes Synthetik Teak in verschiedenen Farben auf dem Laufdeck und dem Kajütdach 3 2 Carbonite Steuerräder im Y-Spoke Design in schwarz oder weiß 4 Große Badeplattform mit fest integrierter Badeleiter aus Edelstahl 5 elektrische Winschen von Lewmar 6 Absenkbarer Kartentisch für große Chaiselongue an Backbord 7 Cockpittisch aus Edelstahl mit faltbaren Teakplatten, optional mit Staufach und Kühlschrank 8 Lazy-Bag mit Lazy-Jacks in verschiedenen Farben



[1](#) Ergonomic helmsman seats with fold-down function [2](#) Elegant teak or synthetic teak with genuine surface texture, in various colours on the sidwalk and the cabin roof [3](#) Carbonite wheels with a Y-spoke design in black or white [4](#) Large bathing platform with fixed, integrated bathing ladder made of stainless steel [5](#) Electric winches by Lewmar [6](#) Lowerable chart table for large chaise loungue portside [7](#) Cockpit table made of stainless steel with fold-down teak tabletops, optional with storage space and refrigerator [8](#) Lazy bag with lazy jacks in various colours

ORIGINAL ACCESSORIES



MADE IN
GERMANY
SINCE 1990



Breaking rules, setting trends – für uns ist das mehr als ein kluger Satz. Es ist eine Haltung, die wir mit jedem neuen Boot Wirklichkeit werden lassen. Eine Haltung, die Sie auf jeder Seemeile fühlen, erleben und genießen werden – und über die Sie auf den nächsten Seiten mehr erfahren.

Breaking rules, setting trends. To us, this is more than just a catchphrase. It is a commitment we make a reality with each finished yacht. A commitment you can feel, experience and enjoy sea mile by sea mile. Discover more about this on the following pages.



BREAKING RULES SETTING TRENDS

“ A blend of striking design, innovative features and very keen pricing has made this yard a real success story. ”

Sailing Today Magazine

Bis heute gewannen HANSE Yachten insgesamt mehr als 62 internationale Auszeichnungen.

To date, yachts made by HANSE have won more than 62 international awards.



6 OVER / ft

Jede fertiggestellte HANSE Yacht setzt Maßstäbe in technologischer Innovation, einfachem Handling und höchster Individualität. Das gilt bis in die höchste Bootsbau-Klasse

“ The HANSE 675 is a dream boat. Putting up the sails becomes a joyful experience: You can easily catch the wind and adjust to the wind strength. Mooring and anchoring



Bei berühmten Regatten feiern HANSE Yachten immer wieder große Erfolge, z.B. auf der Atlantic Rally for Cruisers, der Copa del Ray oder der Nordseewoche.

Time and time again, HANSE yachts achieve great successes in legendary regattas such as the Atlantic Rally for Cruisers, the Copa del Ray or the Nordseewoche.

“Only boats with outstanding performance characteristics deserve the name HANSE.”
Dr Jens Gerhardt | CEO HANSE



HANSE entwirft seine Yachten in Zusammenarbeit mit den Weltklasse-Designern judel/vrolijk & co. Die erste gemeinsame Entwicklung wurde sofort zum Klassiker: die HANSE 371.

HANSE create their yachts in cooperation with world-renowned boat designers judel/vrolijk & co. Our first joint development became an instant classic: the HANSE 371.



“HANSE has a tireless passion for new ideas. It's a pleasure to work with them. And a challenge, too.”
Rolf Vrolijk



In allen Erdteilen schwören Segelbegeisterte auf HANSE. Das Händlernetz der weltweit zweitgrößten Segelyachtwerft liefert in 70 Länder.

All over the world, sailing enthusiasts favour HANSE yachts. The international dealer network of the world's second-largest sailing yacht manufacturer delivers to 70 countries.

“At world's end, HANSE yachts are as highly coveted as in Germany.”
Anthony Bishop | Dealer, Australia

über 60 Fuss. | Each manufactured HANSE yacht sets a new benchmark in technical innovation, easy handling and extreme individuality. This also holds for the largest class in sailboat building over 60 feet.

are also one button push away.” Philippe Fornier | HANSE 675 owner



HANSE steht für Innovationen, die einfach überraschen – und auf die man nie wieder verzichten will. Unser neuestes Beispiel: der E-MOTION RUDDER DRIVE der HANSE 315.

HANSE is best known for inventions that are surprising and indispensable at the same time. The latest example is the E-MOTION RUDDER DRIVE of the HANSE 315.

“Yachts by HANSE are the real 21st century boats. They shape the present and show the way into the future.”

Raoul Bajorat | Head of Development HANSE



“You won't find any production yacht more customisable than a HANSE.”

Maxim Neumann | Sales Director HANSE

Unsere Vielfalt an Polsterstoffen, Möbelhölzern oder Teppichen ergibt für den Eigner tausende Einrichtungsvarianten. Eine so große Auswahl ist einzigartig im Markt.

Thanks to the wide range of upholstery, furniture wood and carpets, we offer thousands of individual furnishing arrangements. A wide choice like this is unique in the market.

89



Anfang der Neunziger revolutionierte die erste, je gebaute HANSE Yacht den Bootsmarkt: Sie wurde als erstes Serienboot mit integrierter Selbstwendefock ausgestattet.

In the early 1990s, the very first HANSE started a revolution in boat building. It featured the first integrated self-tracking jib ever produced in series.

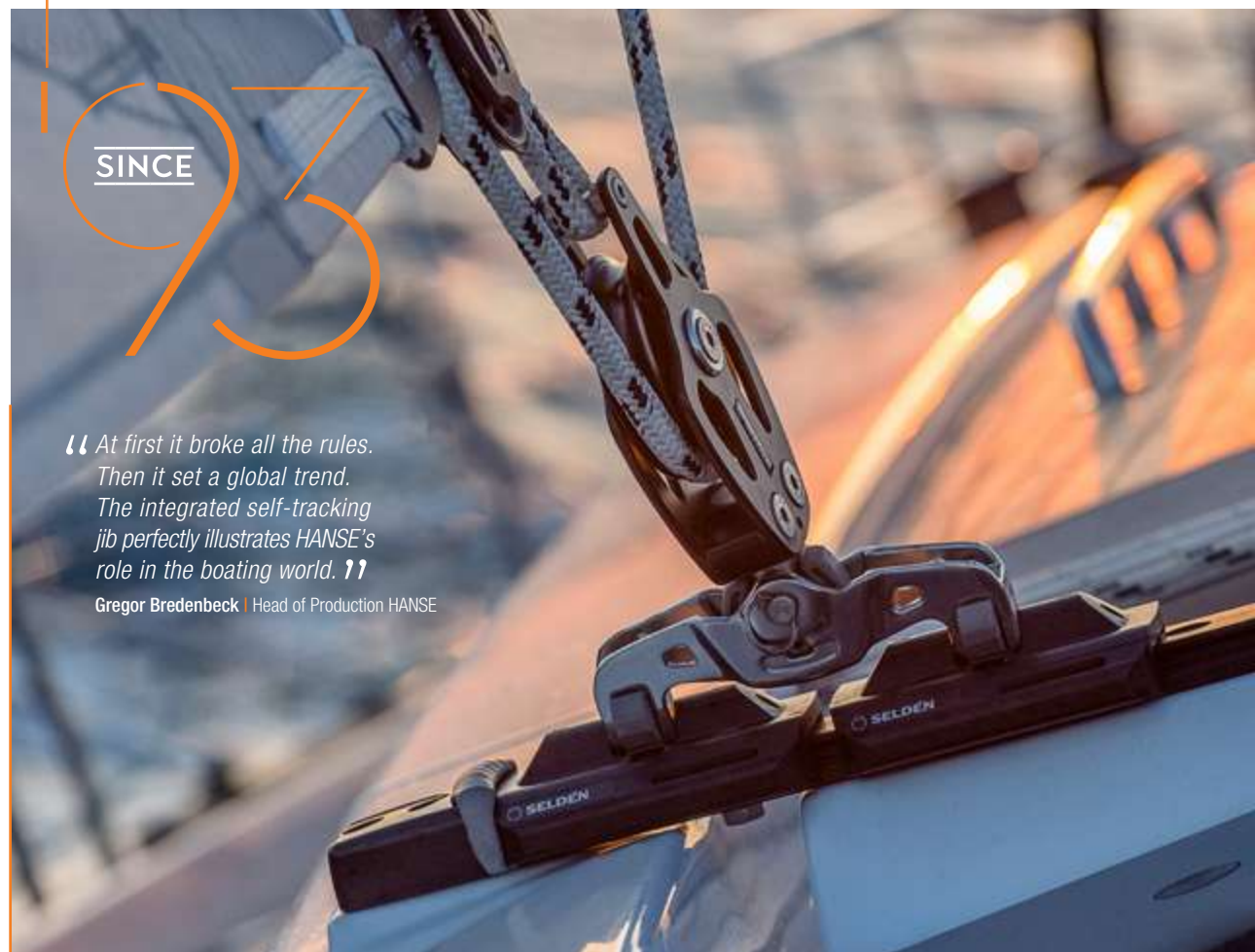

SINCE

“ At first it broke all the rules. Then it set a global trend. The integrated self-tracking jib perfectly illustrates HANSE’s role in the boating world. ”

Gregor Bredenbeck | Head of Production HANSE

Bei HANSE arbeiten 890 segelbegeisterte Profis Hand in Hand. Unterstützt von modernsten Fertigungsprozessen. Getrieben von absoluter Hingabe zum Beruf.

At HANSE, 890 dedicated sailing enthusiasts work together hand in hand. Supported by cutting-edge production processes. Driven by total commitment to their profession.

“ We and our customers are kindred souls: There is nothing we enjoy more than a flawlessly engineered sailing yacht. ”

Pascal Kuhn | Product Marketing HANSE



HANSE YACHTS

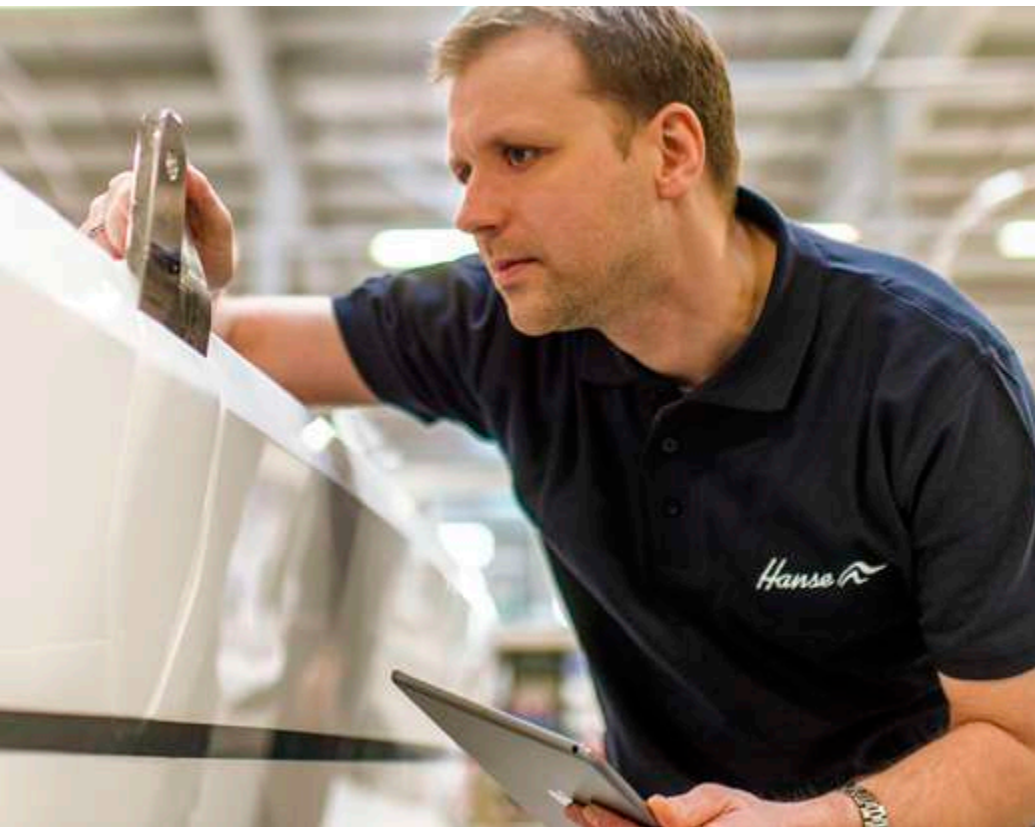

Beeindruckend in jedem Detail, überwältigend als Gesamtwerk: HANSE Yachten sind weit mehr, als die perfekt abgestimmte Verbindung von Design und modernsten Technologien. Sie repräsentieren die Erfahrung und das Wissen der HANSE Ingenieure. Ihre Leidenschaft zum Yachtsport lassen sie in unvergleichlicher Präzision und Akribie in jeder HANSE Wirklichkeit werden.

Impressive in every detail, HANSE yachts are masterpieces made to take your breath away. They are far more than a perfectly harmonised ensemble of design and the most modern technologies. They reflect the experience and know-how of HANSE engineers. Their passion for yachting can be felt in the unmistakable precision and meticulous detailing found in every HANSE.

HANSE
ENGINEERING







BOAT MONITOR*

FRIDGE

Turn on/off remotely

HATCH/DOOR SENSOR

Monitor unauthorized access

LIGHTS

Turn on/off

SHORE POWER

Monitor connection

ENGINE

Monitor activity

MOTION SENSOR

Collision and grounding detection

FUEL TANK

Monitor level

GPS, WIND AND SPEED DATA

BATTERY BANK

Monitor level

WATER TANK

Monitor level

ANCHOR WINCH

Monitor activity

BOW THRUSTER

Monitor activity

BILGE PUMP

Monitor activity

*Steuerung und Sensoren sind abhängig von der Konfiguration Ihrer HANSE. / Controlling and sensors depend on the configuration of your HANSE.

MY HANSE SAFETY CLOUD

Alles unter Kontrolle. Mit der MyHanse Safety Cloud haben Sie vollen Zugriff auf alle wichtigen Daten Ihrer HANSE. Jederzeit und von jedem Ort aus. Intelligente Anwendungen wie BoatMonitoring, eLogBook und eServiceBook ermöglichen es Ihnen, Ihre Yacht unkompliziert und bequem zu überwachen, automatisch Logbuch zu führen und sämtliche Wartungstermine stets im Blick zu behalten.

Everything under control. With the MyHanse Safety Cloud you gain full access to all important data of your HANSE. At any time and any place. Intelligent applications as BoatMonitoring, eLogBook and eServiceBook allow you to supervise your yacht easily and comfortably, to keep the logbook automatically up to date and to keep an eye on all maintenance dates.

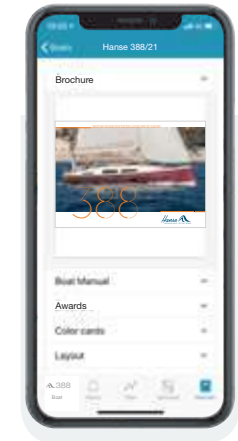

MANUALS

Alle Handbücher und Anleitungen in einer App.

All manuals and instructions within one app.



POSITION

Verfolgen Sie Ihre Position in Echtzeit.

Track your position in real-time.



SENSORS

Überwachen Sie Ladestände und Geräte.

Monitor your charge levels and devices.

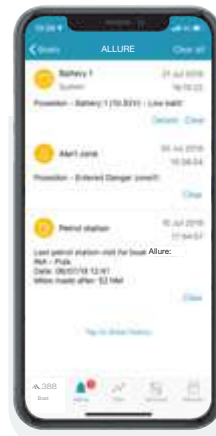

ALARMS

Push-Nachrichten bei aktuellen Ereignissen.

Push notifications on current events.



TRIP LOG

Teilen Sie Ihre geloggtten Törns mit Freunden.

Share your cruises and track data with friends.

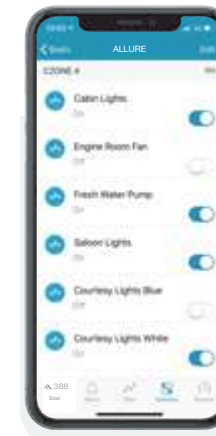

CONTROL

Bedienung elektronischer Geräte per Fernsteuerung.

Operate your electronic devices by remote control.



LIFE REPORT

Direkter Händler Kontakt für schnelle Hilfe.

Direct contact to your dealer for quick help.

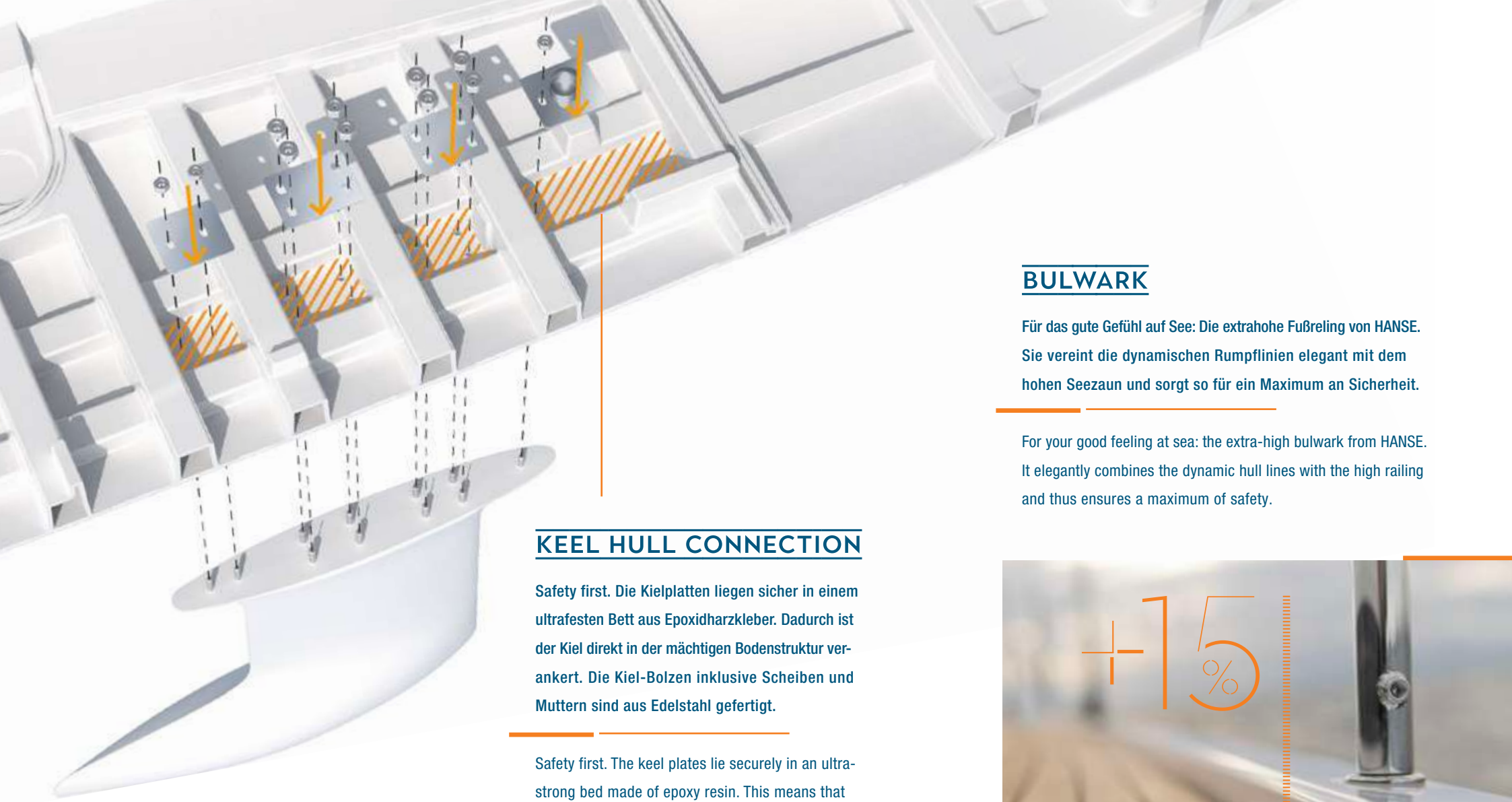

BULWARK

Für das gute Gefühl auf See: Die extrahohe Fußreling von HANSE. Sie vereint die dynamischen Rumpflinien elegant mit dem hohen Seezaun und sorgt so für ein Maximum an Sicherheit.

For your good feeling at sea: the extra-high bulwark from HANSE. It elegantly combines the dynamic hull lines with the high railing and thus ensures a maximum of safety.

KEEL HULL CONNECTION

Safety first. Die Kielplatten liegen sicher in einem ultrafesten Bett aus Epoxidharzkleber. Dadurch ist der Kiel direkt in der mächtigen Bodenstruktur verankert. Die Kiel-Bolzen inklusive Scheiben und Muttern sind aus Edelstahl gefertigt.

Safety first. The keel plates lie securely in an ultra-strong bed made of epoxy resin. This means that the keel is directly anchored in the powerful floor structure. The keel bolts, including discs and nuts, are made of stainless steel.





HULL-DECK CONNECTION

In Zusammenarbeit mit judel/vroljik & co hat HANSE eine spezielle Deck-Rumpf-Verbindung entwickelt, die deutlich über den allgemeinen Anforderungen liegt. Neben dem Einsatz von hochfestem Polyesterklebharz, werden Deck und Rumpf mithilfe von Bolzen in den Klampen zusätzlich verankert und ergeben eine steife, torsionsfreie Yacht mit sportlichem Charakter.

In collaboration with judel/vroljik & co, HANSE has developed a special hull-deck connection which goes well beyond all standard requirements. In addition to the use of highly robust polyester bonding resin, the deck and hull are anchored with the use of high-strength bolts in the cleats. This results in a stable, torsion-free yacht with a sporty character.

SANDWICH CONSTRUCTION

Die HANSE 388 wird im hochwertigen Sandwichverfahren gebaut. Der Rumpf besteht aus mehreren Schichten ausgewählter Materialien und ist bis ins Detail genau berechnet. Er ist dadurch besonders leicht und dank der äußeren Vinylester-Laminatschicht vollkommen resistent gegen Osmose.

The HANSE 388 is constructed using the high-quality sandwich process. The hull features several layers of select materials and is precisely calculated in every detail. It is particularly lightweight and, thanks to the exterior vinylester layer, completely resistant to osmosis.



LOA		11.40 m	37'5"
Hull length		10.99 m	36'1"
LWL		10.40 m	34'1"
Beam		3.90 m	12'10"
Draft			
L-keel, medium		2.06 m	6'9"
L-keel, shallow		1.62 m	5'5"
Displacement			
L-keel, medium	approx.	8.27 t	18,232 lbs
L-keel, shallow	approx.	8.66 t	19,092 lbs
Ballast			
L-keel, medium	approx.	2.38 t	5,247 lbs
L-keel, shallow	approx.	2.75 t	6,062 lbs
Engine diesel			
Standard	approx.	27.30 PS	27.30 HP
Option	approx.	38.00 PS	38.00 HP
Fuel tank	approx.	160 l	42 gal
Fresh water	approx.	295 l	77 gal
CE certification	A - 6 / B - 10		
Design	judel/vrolijk & co		
Interior	HanseYachts Design		

Mast length above WL	approx.	17.60 m	57'9"
Total sail area	approx.	72.00 m ²	775 sq ft
Main sail	approx.	43.50 m ²	468 sq ft
Self-tacking jib	approx.	28.50 m ²	307 sq ft
Crossover	approx.	61.10 m ²	658 sq ft
Gennaker	approx.	93.90 m ²	1,011 sq ft
Rig			
I		14.90 m	48'11"
J		4.31 m	14'2"
P		14.30 m	45'11"
E		5.10 m	16'9"



Beam 3.90 | 12'10"

LOA 11.40 m | 37'5"

All measurements are approximate. Specifications and materials can be change without notice. Errors excepted.



388

SPECIFICATIONS



This brochure is not contractual. The yachts depicted partly comprise special equipment not included in the standard scope of supply. Illustrations may not correspond with current versions. Subject to alterations in design and equipment without notice and errors excepted. Photos/Illustrations: HanseYachts, Nico Krauss, Peter-Paul Rehnuth, Björn Weller, Judo/Wrolijk & co, Malwin Faber, B&G, Fusion, Elvstrom, iStock mapodlife, Fotolia Kieferpix + marralesinh - Design: harksen.de & uffson.de | Print: Druckhaus Panzig

CIB388/F/0920